

# Hydraulic pump

## HY50-108

### PUMP SPECIFICATIONS

Max Capacity [m <sup>3</sup> /h]	250
Max Head [m]	78
Impeller diameter [mm]/type	490 /2 blades closed
Flanged bore size [DN/PN]	DN100/PN10
Solid handling [mm]	35
Weight [kg]	600

### HYDRAULIC MOTOR

Motor displacement [cc]	108
Max. oil flow rate[l/min]	160
Max. pressure [bar]	300
Power [kW-HP]	80 - 110
Speed [RPM]	1450

### MATERIALS

Casing	Spheroidal cast iron EN-GJS500-7 (EN1563)
Motor housing	Cast iron EN-GJL-250 (EN 1561)
Wear parts	High chrome EN-GJN-HV600 (XCr18) (EN12513)
Main shaft	High tensile steel 39NiCroMo3 (AISI 9840)

### SEALS / LUBRICANT

Motor side seals	2 lip seals (BUNA)
Impeller side seals	5 lip seals (3 BUNA + 2PTFE) + 1 V-ring (TPU)
Oil type	ISO 32

### DIMENSIONS [mm]

H	W	D	F	H1	A	B	C
1330	908	774	600	274	374	418	363

### PERFORMANCE CURVES

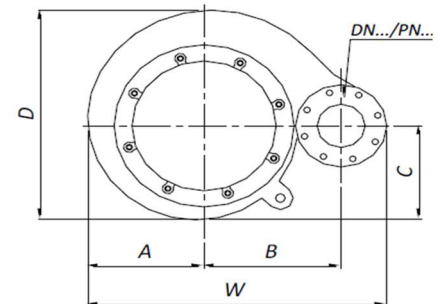
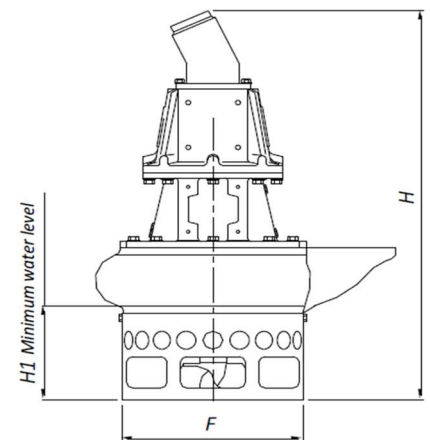
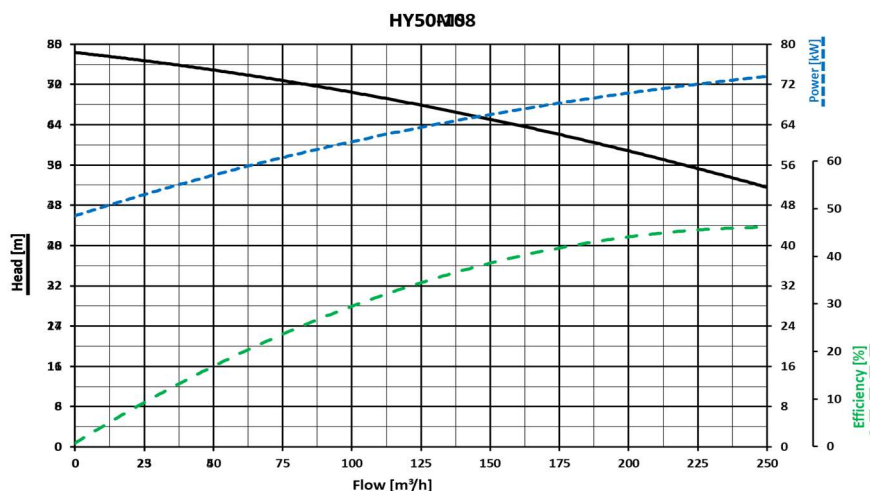

# HY50-108

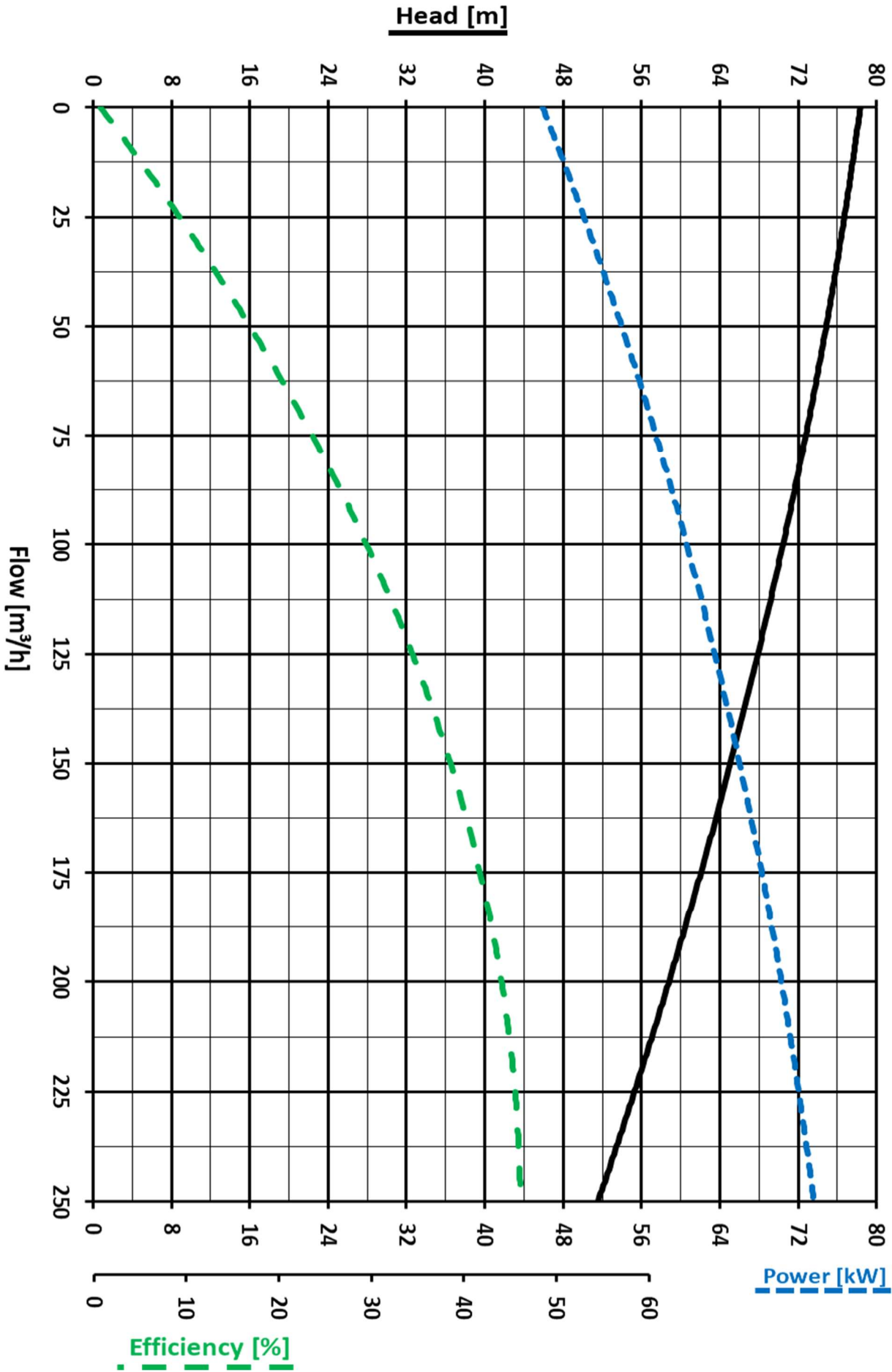

We reserve the right to make changes without notice